



# 48V-4KWP Lithium Battery User Manual

Safety Notice

Only professional engineer with high voltage and alternating current knowledge can install or maintain the batteries.

 High Voltage is dangrous:
High Voltage may cause fatal danger.

 Use professional tools
Use professional tools instead of regular tools.

 Take care of static:
Before touch parts or PCB, take correct anti static action

 Disconnect the power supply during operation:
Disconnect the power supply during operation.

 DC short circuit is dangerous:
DC short circuit will ruin equipment and cause death.

# Contents

Contents.....	<b>Error! Bookmark not defined.</b>
1. Products Introduction.....	<b>Error! Bookmark not defined.</b>
2. Technical Specification .....	<b>Error! Bookmark not defined.</b>
2.1 Battery specification.....	5
2.3 Pilot light introduction.....	7
3. Install, Maintainance Note .....	<b>Error! Bookmark not defined.</b>
3.1 Install Note.....	8
3.2 Maintainance Note.....	8
3.3 Frequently Asked Questions and Solution.....	8
3.3.1 Low Voltage Alarm.....	8
3.3.2 Discharge over current protection.....	9
3.3.3 Temperature Protection.....	9
3.3.4 Battery no voltage output.....	9
4. Pack, Transport, Storage .....	<b>Error! Bookmark not defined.</b>
4.1 Pack.....	9
4.2 Transport.....	9
4.3 Storage.....	10
5. Accessories .....	<b>Error! Bookmark not defined.</b>
6. Battery Setting Advice .....	<b>Error! Bookmark not defined.</b>
7. Battery Connection Advice.....	<b>Error! Bookmark not defined.</b>

## 1. Products Introduction

The battery is composed of 15 strings lithium cells, cells are selected by professional equipments. The battery have characteristics of high energy density, long life, safe, light weight, wide temperature usage range etc, is safe and environment friendly products.

### (1) Charging Battery:

- ◆ 4 capacity led light will be on according to capacity.
- ◆ RUN light will flash per second;
- ◆ If 4 capacity lights are on and RUN light is off, the batteries are charged full.

### (2) Battery Discharging:

- ◆ RUN light is ON;
- ◆ 4 capacity lights are showing capacity.
- ◆ If battery discharge to protection voltage, and in protection status. All lights is off.

### (3) Battery Alarm

If battery have problem, ALM light will flash.

### (4) ADS Dial Code

Dial Code is as below:



Dial code function is to control BMS address. Upside means 1, downside means 0. Four keys means 0、1、2、3、4、5、6、7、8、9、10、11、12、13、14、15, totally 16 addresses.

- ◆ As seen on above picture, 1-4 all are 0, means the address is 0;
- ◆ If 3 is upside, the address is  $2^2=4$ ;
- ◆ If 3 and 4 are upside, the address is  $2^2+2^3=4+8=12$ ;
- ◆ To set address as 3, need 1 and 2 be upside, not to set 3 upside.

**(5) RS232 Monitor Port**

Through RS232 port can send battery working status and alarm message to remote monitor center.

**(6) RS485 Communication Port**

Master Pack can receive Slave Pack data with RS485.

**(7) AIR SWITCH**

Blue key ON means Open, OFF means close

**(8) RST Restart Key**

RST: Means Restart, if system have problem, can use this key to restart system, recover regular work.

RST key hand operation guide	ON	BMS in off status, press 3 seconds to turn on system.
	OFF	BMS not in backup status, press 3 seconds to turn off system.
	Restart	BMS not in backup status, press 10 seconds until all LED lights is ON.

**2. Technical Speicfication.**

**2.1 Battery Pack Specification**

Model	48V-4KWP
Nominal Voltage	52.5V
Usable Capacity	60Ah
Pack Method	15 series connected 9 parallel
Dimension W×D×H(mm)	448.5 (±2) mmmm×≤385 (±5) mm×<3.6U(160)
Weight	25kg
Delivery Voltage	46.5V - 52.5V
Discharge cut off voltage	46.0 V (Adjustable)

## Lithium Power (PTY) Ltd.

Charge Voltage	50.25-52.5V (Float Charge) 52.5-54V (Boost Charge)
Self Discharge Rate	≤2%/Month
Monitor Communication	RS232、RS485 port: Serial Communication
Standard Charge	Constant Current: 10A Cut off current: 0.01CA
Install Method.	19 inch rack、wall mounted、pole mounted
Working Condition	Temperature: -20℃ ~ +60℃; Humidity: ≤95%; Altitude: ≤4000m
Protection Function	Overcharge、Over discharge、Short Circuit、Over Load、Over Temperature.

## 2.2 Communication Port

### 2.2.1 RS232 Port

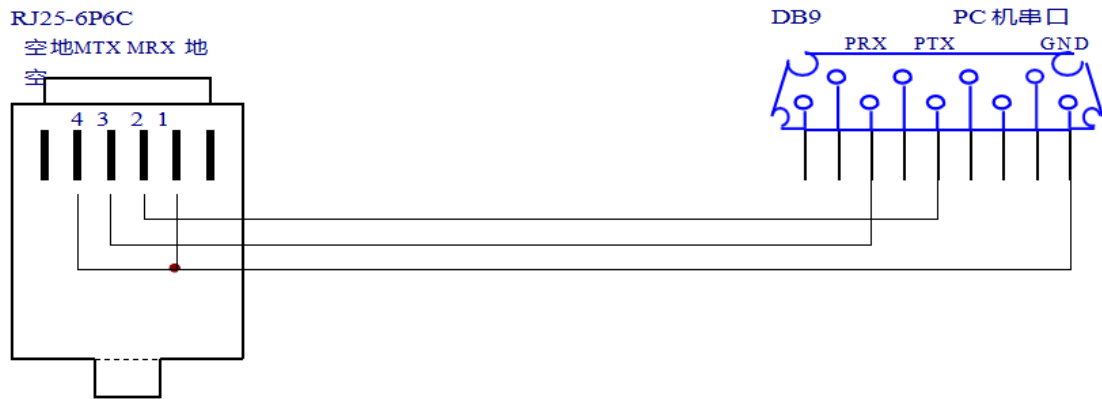

### 2.2.2 RS485 Port

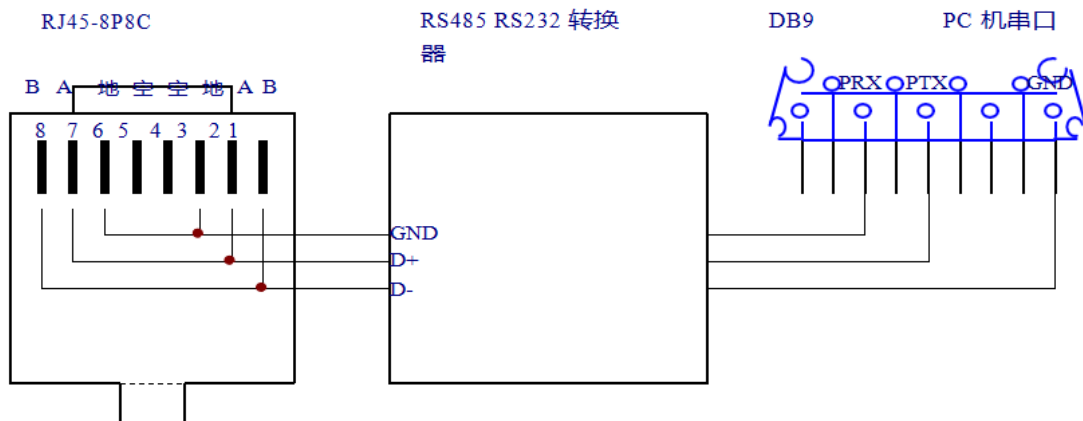

## 2.3 Indication light introduction

### 2.3.1 Capacity Indication

Status	Charge				Discharge				
Capacity Light	L4 ●	L3 ●	L2 ●	L1 ●	L4 ●	L3 ●	L2 ●	L1 ●	
Capacity %	0-25%	OFF	OFF ●	OFF	Flash 2	OFF	OFF ●	OFF	ON
	25-50%	OFF ●	OFF	Flash 2	ON	OFF ●	OFF	ON	ON
	50-75%	OFF	Flash 2	ON	ON ●	OFF	ON	ON	ON
	75-100%	Flash 2	ON	ON	OFF	ON	ON	ON	ON
Run light ●	ON				Flash 3				

### 2.3.2 Status Indication

Status	Normal/Alarm/Protection	RUN	ALM	Capacity indication LED				Explanation
		●	●	●	●	●	●	
OFF	SLEEP	OFF	OFF	OFF	OFF	OFF	OFF	All OFF
Stand by	Normal	Flash 1	OFF	Display with capacity				Stand By
	Alarm	Flash 1	Flash 3					low voltage
Charge	Normal	ON	OFF	Display with capacity				Max capacity LED flash, Overcharge alarm ALM do not flash
	Alarm	ON	Flash 3					
	Overcharge Protect	ON	OFF	ON	ON	ON	ON	If no grid, indicator stand by
	Temperature, Overcurrent protect	OFF	ON	OFF	OFF	OFF	OFF	Stop Charge
Discharge	Normal	flash 3	OFF	Display with capacity				
	Alarm	flash 3	flash 3					
	Low voltage protect	OFF	OFF	OFF	OFF	OFF	OFF	Stop Discharge
	Temperature, Overcurrent, short circuit protect	OFF	ON	OFF	OFF	OFF	OFF	Stop Discharge
Invalid		OFF	ON	OFF	OFF	OFF	OFF	Stop Charge, Discharge

## Install, Maintenance Note

### 3.1 Install Note:

- (1) Open boxes, check the parts number and battery appearance.
- (2) Install handle, use multi meter to test battery voltage, normally delivery battery voltage is between 46.5V - 51V.
- (3) Check the battery anode and cathod carefully , never connect anode and cathod reversely.
- (4) Avoid short circuit.
- (5) Make sure power system is switched off.
- (6) Cables must be insulated.

### 3.2 Maintenance Attention

Maintain battery once per three months.

- ◆ Check the battery terminals, cables, containers.
- ◆ Check the led lights status.
- ◆ If ALM red light flash, check battery terminals are connected correctly or if over current, then press RST key, restart battery to see if problems are solved, if can not solve please contact battery factory.
- ◆ For several strings batteries series connected, if one string battery need to replace, make sure new battery voltage and other batteries voltage difference is less than 2V. If more than 2V, high voltage battery will charge low voltage battery, and low voltage battery will protect and can not charge.
- ◆ Record power off time and frequency, remember detail power supply time.

### 3.3 Frequently Asked Questions and Solution

#### 3.3.1 Low voltage alarm

Phenomenon: ALM light flash, RUN light off.

Reason:

- (1) Load current is too big, more than protection value.
- (2) BMS have problem.

Solution: BMS will lock down if over current, until charger connected will activate.



### **3.3.2 Discharge Over Current Protection**

Phenomenon: ALM light flash, RUN indication light off.

Reason:

- (1) Load current is too big, more than protection value
- (2) BMS have problem.

Solution: BMS will lock down if over current, until charger connected will activate.

### **3.3.3 Temperature Protection**

Phenomenon: ALM light flash, RUN indication light off.

Reason: Working temperature is too high or too low.

Solution: if working temperature recover to normal value, BMS will recover from protection, red ALM light will be off.

### **3.3.4 Battery do not have voltage output.**

Phenomenon: Capacity light off, test the battery voltage is 0V.

Reason: Battery is not activated or BMS has problem.

Solution: Activate battery or press RST to recover battery if battery is activated.

If still no voltage output, please contact battery factory engineer.

## **3. Pack, Transport, Storage.**

### **4.1 Pack**

Battery pack should be packed strongly.

### **4.2 Transport.**

Take Attention:

- (1) Move lightly, avoid shock.
- (2) Do not throw battery, avoid broke battery appearance.
- (3) Do not expose to sun or rain, or put in water.
- (4) Do not short circuit.

### 4.3 Storage

- (1) Keep terminals in insulation protection state.
- (2) If stored more than 3 months, charge it 2-3hours with 0.2C-0.3C current.
- (3) Keep battery in dry, clean, ventilate room, far from fire and do not expose to sun.
- (4) Do not store batteries in temperature more than 60 Celsius degree.

## 5. Battery Setting Advice

- (1) If discharge 3 hours rate, the discharge coefficient ratio suggest 0.9.
- (2) If discharge 1 hour rate, discharge coefficient ratio suggest 0.8. But do not suggest to discharge with 1HR, the battery is full load work, may influence the battery cycle life.

## 6. Battery Connection Advice

Suggest to use 25 square mm cable to connect, if more than 2 strings please connect to bus bar, and then connect to power switch through bus bar.

## 7. Product Drawing

